

Hot-fill DOS2 with accessories

5002

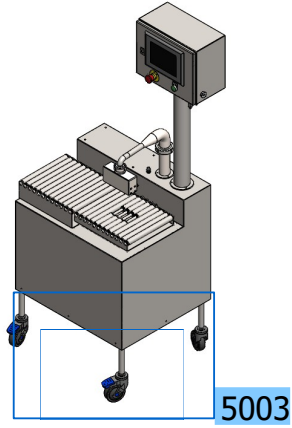

5003

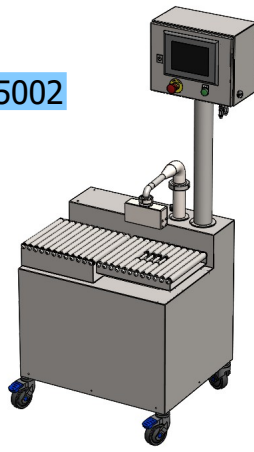
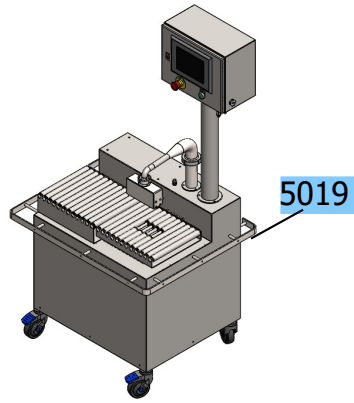

5019

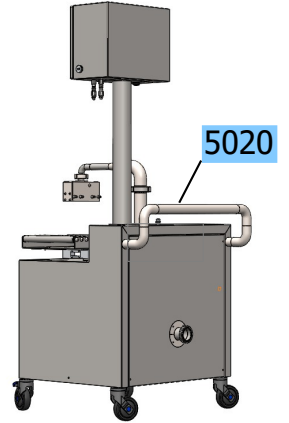

5020

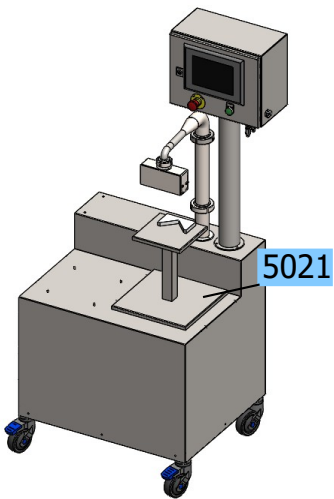

5021

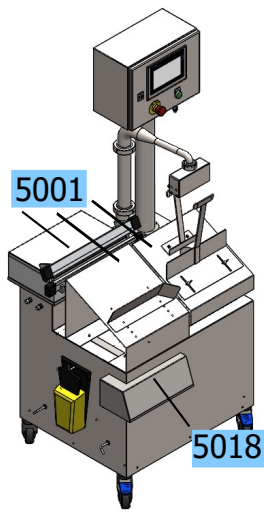

5001

5018

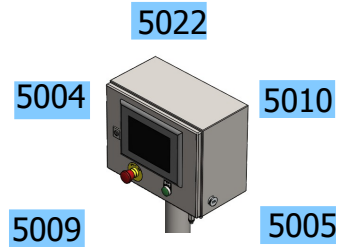

5022

5004

5010

5009

5005

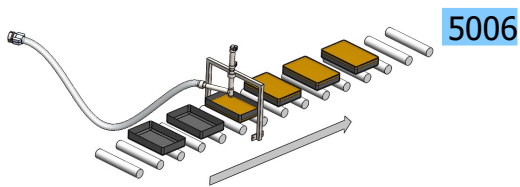

5006

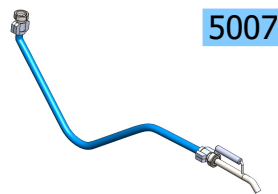

5007

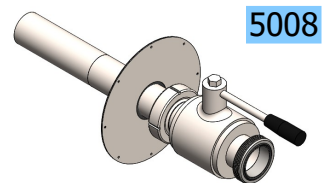

5008

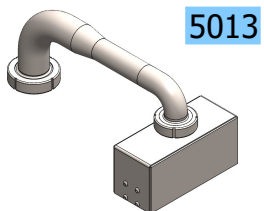

5013

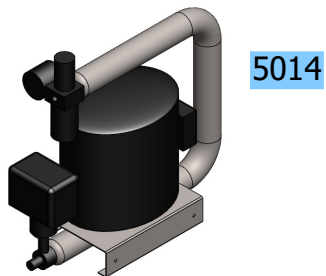

5014

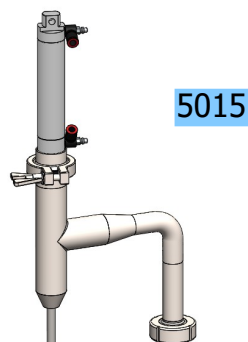

5015

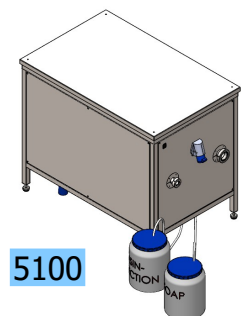

5100

Hot-fill Dos 2 with accessories

Item no.	Description
5002	Hot-fill Dos 2 with conveyor for containers etc. For dispensing thin and thick products with particles up to the size of 30mm. Built-in scale for accurate weighing of the dispensed portions. Temperature display on touch screen
5001	Bag holder, adjustable plate and bag welder, for dispensing from pot to hot-fill bags
5003	Ergonomic height adjustment of the Hot-fill op to 300 mm – programmed at the touch screen
5004	PT100 temperature sensor Equipped with an alarm for monitoring product temperature, entered at the touch screen – if the product temperature falls below the minimum temperature, the alarm starts
5005	PT100 temperature sensor – with data log Equipped with an alarm for monitoring product temperature, entered at the touch screen – if the product temperature falls below the minimum temperature, the alarm starts. Data log for saving temperatures, batch no., date and time. The data can be saved at an USB pen
5006	Remote dispensing by pulse to tray sealer or deep-draw etc. The Hot-fill is prepared to receive signal from other machines
5007	Pistol with start/stop by footswitch for dispensing directly into canteens, roasting pans, soup buckets - 3 m D25 tube
5008	Bottom valve For mounting in the pot with coupling to hot-fill
5009	Quick switching between 8 different scales of weights – by a single touch at the touch screen, it is possible to select a new scale of weight
5010	Dispensing by pulse For dosage of product , where the packing is not placed at the plate
5013	Filling valve for Hot-fill Dos 2 – D38 For dispensing of product containing large particles
5014	Silent built-in air compressor
5015	Filling valve for bottles
5018	Knee control, start of the bag welder Left mounted
5019	Bumper for Hot-fill Dos 2
5020	Safety handle for moving Hot-fill Dos 2
5021	Height adjustable platform – for different heights at trays, bottles and buckets. The platform is mounted with adjustable fixation placing the tray etc. under the filing valve
5022	Auto-timer – for time dosage
5100	Fully automatic CIP Unit for Hot-Fill Dos 2 For cleaning of all tubes and pipes