

DESCRIPTION: 55126 Sous-Vide

PART NO.

WEIGHT: kilograms.

MATERIAL:

CLIENT:

DRAWN BY:

DRAWN DATE:

SHEET 2 OF 3

A4

SCALE:1:25

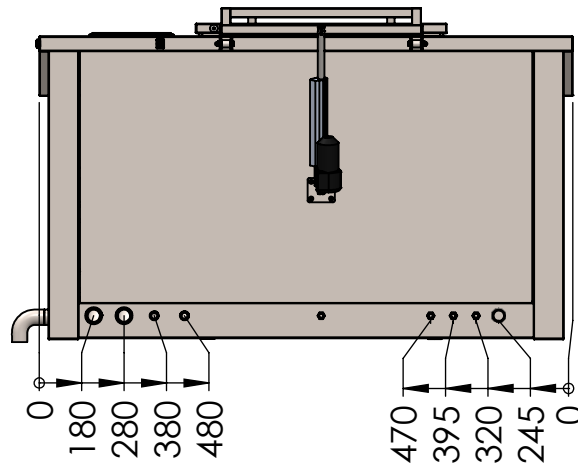

Tube dia. 51mm. to drain,
Dia. 100mm.

Glycol in:
1½" male thread.

Glycol out:
1½" male thread.

Cold water in:
¾" male thread. 2,5bar.

Hot water in:
¾" male thread. 2,5bar.

Power connection:
38kW. 54amp.

Internet to pc:
(DHCP CAT6 STP cable)

Ethernet to pc:
(DHCP CAT6 STP cable)

Signal cable to Chiller.



DESCRIPTION:

55126 Sous-Vide

PART NO.

WEIGHT: kilograms.

MATERIAL:

CLIENT:

DRAWN BY:

DRAWN DATE:

SHEET 3 OF 3

A4

SCALE:1:25